

# MPFHVLP

## Mini Pressure Feed Spray Gun

309990D



### Important Safety Instructions

Read all warnings and instructions in this manual. Save these instructions.

*Maximum Air and Fluid Inlet Pressure: 50 psi (345 kPa, 3.4 bar)*





*Maximum HVLP Compliant Air Pressure: 40 psi (276 kPa, 2.8 bar)*

### Part No. 7045 Spray Gun

For pressure feed spraying of automotive colors and clears.



 **WARNING**

	<p><b>FIRE AND EXPLOSION HAZARD</b></p> <p>Flammable fumes, such as solvent and paint fumes, in work area can ignite or explode. To help prevent fire and explosion:</p> <ul style="list-style-type: none"> <li>• Use equipment only in well ventilated area.</li> <li>• Eliminate all ignition sources; such as pilot lights, cigarettes, portable electric lamps, and plastic drop cloths (potential static arc).</li> <li>• Keep work area free of debris, including solvent, rags and gasoline.</li> <li>• Do not plug or unplug power cords or turn lights on or off when flammable fumes are present.</li> <li>• Ground equipment and conductive objects in work area.</li> <li>• If there is static sparking or you feel a shock, <b>stop operation immediately</b>. Do not use equipment until you identify and correct the problem.</li> </ul>
	<p><b>EQUIPMENT MISUSE HAZARD</b></p> <p>Misuse can cause death or serious injury.</p> <ul style="list-style-type: none"> <li>• Do not exceed the maximum working pressure or temperature rating of the lowest rated system component. See <b>Technical Data</b> in all equipment manuals.</li> <li>• Use fluids and solvents that are compatible with equipment wetted parts. See <b>Technical Data</b> in all equipment manuals. Read fluid and solvent manufacturer's warnings.</li> <li>• Check equipment daily. Repair or replace worn or damaged parts immediately.</li> <li>• Do not alter or modify equipment.</li> <li>• Use equipment only for its intended purpose. Call your Graco distributor for information.</li> <li>• Route hoses and cables away from traffic areas, sharp edges, moving parts, and hot surfaces.</li> <li>• Do not use hoses to pull equipment.</li> <li>• Keep children and animals away from work area.</li> <li>• Comply with all applicable safety regulations.</li> </ul>
	<p><b>TOXIC FLUID OR FUMES HAZARD</b></p> <p>Toxic fluids or fumes can cause serious injury or death if splashed in the eyes or on skin, inhaled, or swallowed.</p> <ul style="list-style-type: none"> <li>• Read MSDS's to know the specific hazards of the fluids you are using.</li> <li>• Store hazardous fluid in approved containers, and dispose of it according to applicable guidelines.</li> </ul>
	<p><b>PERSONAL PROTECTIVE EQUIPMENT</b></p> <p>You must wear appropriate protective equipment when operating, servicing, or when in the operating area of the equipment to help protect you from serious injury, including eye injury, inhalation of toxic fumes, burns, and hearing loss. This equipment includes but is not limited to:</p> <ul style="list-style-type: none"> <li>• Protective eyewear</li> <li>• Clothing and respirator as recommended by the fluid and solvent manufacturer</li> <li>• Gloves</li> <li>• Hearing protection</li> </ul>
	<p><b>PRESSURIZED EQUIPMENT HAZARD</b></p> <p>Fluid from the gun/dispense valve, leaks, or ruptured components can splash in the eyes or on skin and cause serious injury.</p> <ul style="list-style-type: none"> <li>• Follow <b>Pressure Relief Procedure</b> in this manual, when you stop spraying and before cleaning, checking, or servicing equipment.</li> <li>• Tighten all fluid connections before operating the equipment.</li> <li>• Check hoses, tubes, and couplings daily. Replace worn or damaged parts immediately.</li> </ul>

## 2 Year Limited Warranty

Sharpe warrants this product to the original user against defective material or workmanship for a period of 1 year from the date of purchase.

Sharpe reserves the right to determine whether the part or parts failed because of defective material, workmanship, or other causes. Failures caused by accident, alteration, or misuse are not covered by this warranty.

Sharpe, at its discretion, will repair or replace products covered under this warranty free of charge. Repairs or replacements of products covered under this warranty are warranted for the remainder of the original warranty period.

Sharpe or its authorized service representatives must perform all warranty repairs. Any repair to the product by unauthorized service representatives voids this warranty. The rights under this warranty are limited to the original user and may not be transferred to subsequent owners.

This warranty is in lieu of all other warranties, expressed or implied, including warranties of merchantability and fitness for a particular purpose. Some states do not allow the exclusion or limitations of incidental or consequential damages, so the above limitations may not apply to you.

## Setup

- Set shop air pressure regulator (not supplied) according to paint manufacturer's recommendation. See maximum air and fluid pressures on cover.
  - Make sure no air restrictions, such as low-volume cheater-valves, obstruct the air flow. If an air adjusting valve is desired, use a SHARPE Air Adjusting Valve 24AAV (part no. 2210), 36AAV-HOV (part no. 3310) or HOV (part no. U04410).
  - Install a shutoff valve (not supplied) downstream of the air regulator to shut off gun air.
  - Install an inline air filter (not supplied) to clean and dry the air supply to the gun.
1. Turn off air and fluid supply.
  2. Connect a clean, dry, filtered air supply to gun air inlet (2).
  3. Connect fluid supply line to gun fluid inlet (A).
  4. If this is first time using the equipment, flush the spray gun.

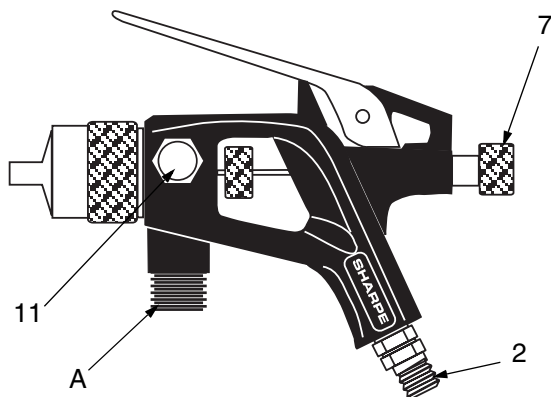



FIG. 1

## Operation

### Pressure Relief Procedure

 <b>WARNING</b>

<p>Follow <b>Pressure Relief Procedure</b> when you stop spraying and before cleaning, checking, or servicing equipment. Read warnings, page 2.</p>

1. Turn off gun air and fluid supply.
2. Trigger the gun to relieve pressure.

## Flushing

 <b>WARNING</b>
 
<p>Read warnings, page 2.</p>

Flush before using the equipment, before changing colors, and when you are done spraying. Use solvent that is compatible with gun wetted parts and fluid that will be sprayed. Flush at lowest possible pressure.

 Refer to **Compliant Cleaning Methods**, page 4, to comply with air quality laws if applicable.

1. Follow **Pressure Relief Procedure**.
2. Connect solvent supply to gun fluid inlet.
3. Spray into grounded metal waste container until equipment is clean.
4. Follow **Pressure Relief Procedure**.

## Spraying

<b>CAUTION</b>
<p>Excessive atomizing air pressure can increase over-spray, reduce transfer efficiency, result in a poor quality finish from dry spray.</p> <p>Regulatory agencies in certain states prohibit the operation of a spray gun above 10 psi (69 kPa, .7 bar) atomizing air cap pressure.</p>

1. Slowly adjust gun air pressure while fully triggering the gun until you have the desired atomization.
2. Adjust the pattern size and shape with the spray width adjustment knob (11). Turn knob clockwise to reduce pattern size and counterclockwise to increase it.

 See **Troubleshooting** guide if you experience an irregular pattern.

3. Fluid control knob (7) is factory set for maximum needle trigger travel and material flow. To decrease needle/trigger travel and decrease fluid flow, turn knob clockwise.

## Cleaning and Maintenance

### WARNING



Follow **Pressure Relief Procedure** when you stop spraying and before cleaning, checking, or servicing equipment. Read warnings, page 2.

### CAUTION

- Do not submerge gun in solvent. Solvent dissolves lubricant, dries out packings, and may clog air passages.
- Do not use metal tools to clean air cap holes as this may scratch them and distort the spray pattern.
- Use a compatible solvent.
- Gun can be cleaned in a gun washer.



Clean air line filters as directed by the manufacturer.

### Volatile Organic Compounds (VOC) Regulation

In certain states, spraying solvents that release VOC's into the atmosphere when cleaning a spray gun is prohibited. To comply with these air quality laws you must use a cleaning method that prevents the escape of VOC vapors into the atmosphere. See **Compliant Cleaning Methods** below.

#### Compliant Cleaning Methods

- Place spray gun in a gun washer that completely encloses the gun and components during cleaning, rinsing, and draining.
- Spray solvent through the spray gun into a closed gun cleaning station.

### Cleaning Gun



Refer to **Compliant Cleaning Methods** to comply with air quality laws if applicable.

1. Follow **Flushing** procedure, page 3.

2. Use a rag moistened in solvent to wipe outside of gun.
3. Blow dry gun inside and out. Lubricate gun as described in **Spray Gun Maintenance**.

### Cleaning Nozzle and Air Cap

#### CAUTION

- Trigger gun whenever you tighten or remove nozzle to avoid damaging needle seat and nozzle.
- Do not use metal tools to clean air cap holes as this may scratch them and distort the spray pattern.

To clean the air cap and nozzle, remove and soak them in a compatible cleaning solution. Clean them and front of gun with a soft-bristle brush dipped into compatible solvent. Do not use a wire brush or metal tools. To clean out air cap holes, use a soft implement, such as a toothpick.



### Spray Gun Maintenance

- Frequently lubricate the gun moving parts with a drop of non-silicone oil (part no. 8255).
- Do not disassemble the spray gun if you are having a spray pattern problem. Check **Troubleshooting**, page 5, for information on how to correct the problem.
- Check for fluid leakage. Tighten fittings or replace equipment as needed.

## Technical Data

**Maximum Air and Fluid Inlet Pressure:** 50 psi (345 kPa, 3.4 bar)

**Maximum HVLP Compliant Air Pressure:** 40 psi (276 kPa, 2.8 bar) - delivers 10 psi (69 kPa, 0.7 bar) spraying pressure at air cap

**Wetted Parts:** stainless steel, aluminum, brass, L/D polyethylene

**Air Consumption:** 3.5 CFM at 40 psi (276 kPa, 2.8 bar)

#### Spray Gun

- 1/4 npsm (R1/4-19) air and fluid inlets
- Weight - 8 oz. (227 grams)





## Troubleshooting



### WARNING

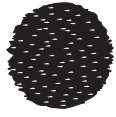

Follow **Pressure Relief Procedure**, page 3, before troubleshooting or servicing. Read warnings, page 2.

Problem	Cause	Solution
 <b>Right</b>	Normal pattern	No action necessary
 <b>Wrong</b> Heavy top or bottom pattern	Dirty or damaged air cap or fluid nozzle.	Rotate air cap 180°. <i>If pattern follows air cap</i> , problem is in air cap. Clean and inspect. If pattern is not corrected, replace air cap. <i>If pattern does not follow the air cap</i> , the problem is with the fluid nozzle. Clean and inspect the nozzle. If the pattern is not corrected, replace nozzle.
 <b>Wrong</b> Split pattern	Pressure too high for viscosity of material being sprayed.	a. Reduce air pressure. b. Increase material viscosity c. Correct pattern by narrowing fan size with spray width adjustment knob.
 <b>Wrong</b>	Dirty or distorted air horn holes.	Rotate air cap 180°. <i>If pattern follows air cap</i> , problem is in air cap. Clean and inspect. If pattern is not corrected, replace air cap.
Will not spray.	Fluid supply empty.	Fill fluid supply.
 <b>Wrong</b> Heavy pattern or orange peel	a. Fluid pressure too high for viscosity of material being sprayed. b. Air pressure too low. c. Gun held too close to surface.	a. Reduce fluid pressure. b. Increase air pressure. c. Hold gun about 6-8 inches (150-200 mm) from surface.

# MPFHVLP SPRAY GUN

## Parts

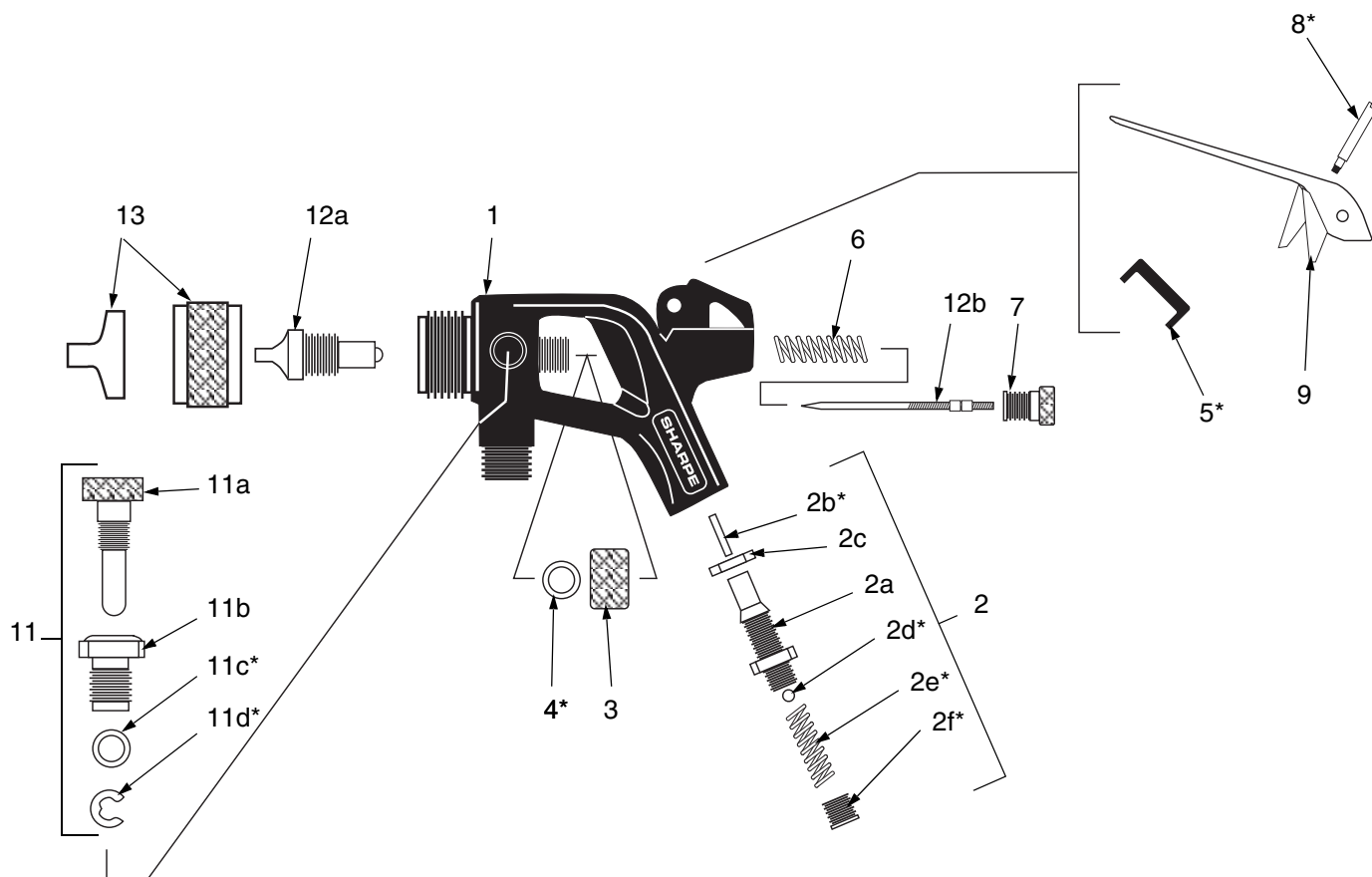

Ref. No.	Part No.	Description	Qty.	Ref. No.	Part No.	Description	Qty.
1	34802	Gun Body	1	12a	34811	• Fluid Nozzle	1
2	34825	Air Valve Assembly Includes items 2a-2f	1	12b	29040	• Fluid Needle	1
2a	34819	• Housing	1	13	34808	Air Cap	1
2b*	29049	• Air Valve Stem	1	* Parts included in Repair Kit 34835.			
2c	29053	• Lock Nut	1				
2d*	29050	• Ball	1				
2e*	29036	• Needle Spring	1				
2f*	34823	• Retainer	1				
3	29033	Needle Packing Nut	1				
4*	26022	Needle Packing	1				
5*	29047	Plunger	1				
6	29036	Needle Spring	1				
7	29046	Fluid Control Knob	1				
8*	29056	Trigger Screw	1				
9	29055	Trigger	1				
11	29030	Width Control Assembly Includes items 11a-11d	1				
11a	118749	• Knob	1				
11b	118741	• Packing Nut	1				
11c*	29028	• Packing	1				
11d*	29029	• Retaining Ring	1				
12	118956	Fluid Needle Assembly Includes items 12a-12b	1				